



Instruction Manual

ZEISS Axiocam 208 color / 202 mono
Microscope Camera



ZEISS Axiocam 208 color / 202 mono

Original Manual

Carl Zeiss Microscopy GmbH
Carl-Zeiss-Promenade 10
07745 Jena
Germany
microscopy@zeiss.com
www.zeiss.com/microscopy



Carl Zeiss Suzhou Co., Ltd.
Modern Industrial Square 3-B, No.333 XingPu Road SIP
215126 Suzhou
China

Document Name: ZEISS Axiocam 208 color / 202 mono Instruction Manual
Order Number: 426570-7011-001
Revision: 5
Language: en-US
Effective from: 11/2021

© 2021 Without the prior written consent of ZEISS, this document or any part of it must neither be translated nor reproduced or transmitted in any form or by any means - including electronic or mechanic methods, by photocopying, recording or by any information or filing system. The right to make backup-copies for archiving purposes shall remain unaffected thereby. Any violations may be prosecuted as copyright infringements.

The use of general descriptive names, registered names, trademarks, etc. in this document does not imply that such names are exempt from the relevant intellectual property laws and regulations and therefore free for general use. This shall also apply if this is not specifically referred to. Software programs shall entirely remain the property of ZEISS. No program or subsequent upgrade thereof may be disclosed to any third party, copied or reproduced in any other form without the prior written consent of ZEISS, even if these copies or reproductions are destined for internal use at the customer's only, the only exception being one single back-up copy for archiving purposes.

Content

1	General Information	5
1.1	Introduction	5
1.2	Text Conventions and Link Types	5
1.3	Explanation warning messages and additional information	6
2	Safety	7
2.1	Intended use	7
2.2	Prevention of hazards	7
2.3	Limitation of liability	8
2.4	Warranty	8
2.5	Warning labels	8
2.5.1	Position of the warning labels	9
2.5.2	Meaning of the warning labels	9
3	Technical Data and Conformity	10
3.1	Axiocam 208 color	10
3.1.1	Specifications	10
3.1.2	Spectral Sensitivity	12
3.2	Axiocam 202 mono	12
3.2.1	Specifications	12
3.2.2	Spectral Sensitivity	14
3.3	Applicable Standards and Regulations	15
3.3.1	Symbols on the camera	15
4	Shipment	16
4.1	Axiocam 208 color	16
4.2	Axiocam 202 mono	16
5	Connecting the Camera	17
5.1	Camera layout and accessories	17
5.1.1	Camera connections	17
5.1.2	Camera controls	17
5.1.3	Accessories	18
5.2	Mounting the camera to the microscope	20
5.3	Connecting the camera to the power supply	21
5.3.1	Powering the camera via microscope	21
5.3.2	Powering the camera via mains supply	21
5.4	Connecting the camera to a display (without PC)	22

5.5	Connecting the camera to a network	22
5.5.1	Connecting camera via Ethernet	23
5.5.2	Connecting camera via Wi-Fi adapter	23
5.6	Connecting the camera to a certified PC.....	24
5.7	Function indicator signals	25
6	On Screen Display (OSD) Menu	26
6.1	Opening the OSD menu	26
6.1.1	Opening menu via camera's operator panel.....	26
6.1.2	Opening menu via microscope stand buttons	26
6.1.3	Opening menu via network browser.....	26
6.2	Home menu	27
6.3	Settings menu	30
6.3.1	Image Settings menu.....	31
6.3.2	Microscope System menu.....	32
6.3.3	Operating System menu	34
7	Installing Software and Drivers	39
7.1	Installing software on PC.....	39
7.2	Installing software on iPad	39
7.3	Installing TWAIN plugin on PC.....	39
7.4	Installing TWACKER DEMO Application	39
8	Acquiring Images and Videos	41
8.1	Introduction	41
8.2	Basic procedure using operator panel.....	41
8.3	Basic procedure using OSD menu	41
8.4	Image acquisition with Labscope.....	41
9	Care and Maintenance.....	43
9.1	Optical system.....	43
9.2	Cleaning the infrared filter or protective glass.....	43
9.3	Updating the firmware	43
10	Troubleshooting	45
10.1	ZEN software.....	45
10.2	Camera	46
10.3	Labscope.....	47
11	Disposal and Recycling	48

1 General Information

1.1 Introduction

Welcome to the Axiocam 208 color / Axiocam 202 mono user guide.

These cameras are multi-functional digital CMOS cameras for use in light microscopy applications. To make it easier for you to set up the camera, please follow the instructions in these chapters step by step.

Content	Chapter	Content
	About this guide	Introduction and overview of this manual.
	Safety	Important information on the safe handling of the camera. Read this chapter before unpacking and operating the camera.
	Technical data	Here you will find your camera's technical data.
	Shipment	The contents of delivery and optional attachments will be described here.
	Connecting the camera	In this chapter, you will find detailed instructions on connecting and using the camera.
	OSD menu	This chapter lists the functions of the On Screen Display (OSD) menu.
	Installing software and drivers	Here you will learn how to install the software and camera drivers.
	Acquiring images	This chapter provides the basics of image acquisition.
	Troubleshooting	In this chapter, we have listed some solutions to various problems. If you are still unable to solve your problem, contact ZEISS support.
	Maintenance	This chapter describes some measures for the maintenance and care of your camera. In case of greater damage, always contact ZEISS support.
	Disposal and Recycling	Important instructions for disposal and recycling.

1.2 Text Conventions and Link Types

The following text conventions and link types are used:

Text convention	Meaning
Click Start .	The names of controls and important information are shown in bold letters.
Press the STANDBY button.	
Press [Enter] on the keyboard.	
Press <Ctrl+Alt+Del>	Press several keys on the keyboard simultaneously.

Text convention	Meaning
Select Tools > Goto Control Panel > Airlock .	Follow a path in the software.
<i>Text input</i>	Text to be entered by the user
Programming and Macros	Anything typed in literally during programming, including, for example, macro codes, keywords, data types, method names, variables, class names, and interface names.

Tab. 1: Text convention

Link type	Meaning
See: <i>Text Conventions and Link Types</i> [▶ 5].	Link to further information for this topic.
https://www.zeiss.com/corporate/int/home.html	Link to a website on the internet.

Tab. 2: Link types

1.3 Explanation warning messages and additional information

The safety notes in this document follow a system of risk levels, defined in the following manner:

CAUTION

Risk of personal injury

CAUTION indicates a potentially hazardous situation which, if not avoided, may result in minor or moderate personal injury.

NOTICE

Risk of property damage

NOTICE indicates a property damage message. In addition, NOTICE is used for data loss or corrupt data.

Info

Indicates useful additional information. It helps you to make your daily work easier, but it is optional. There is no risk for personal injury or property damage involved.

2 Safety

2.1 Intended use

The Axiocam 208 color and the Axiocam 202 mono are high definition cameras for color and monochromatic imaging, respectively. They are suitable for use as accessories for educational and routine microscopy in laboratory environments and for use by trained laboratory personnel. The cameras have been designed to be used in the field of light microscopy for general observation, routine work, and simple applications in which a sufficient amount of light is available.

These cameras should only be used for training and research. The images / videos from these cameras must not be used for the direct generation of diagnostic results.

2.2 Prevention of hazards

Axiocam 208 color and Axiocam 202 mono have been manufactured and tested by ZEISS according to the regulations specified in CE and has left the manufacturer's premises in perfect working order. The cameras are intended to be used in a basic electromagnetic environment while the noise emission conforms to CISPR 11 Class B level. The EMC performance might be impaired while integrated into a system. In order to ensure that this condition is maintained and to avoid any risks when operating the system, the user must comply with any notes and warnings contained in this manual. The manufacturer shall be exempt from statutory liability for accidents should the operator fail to observe the safety regulations.

CAUTION

Personal Injury

To avoid personal injury, read and adhere to the safety notes below.

- ▶ To avoid the risk of fire or explosion, do not use the camera near inflammable liquids or gases.
- ▶ Setup, expansions, re-adjustments, alterations, and repairs must be carried out only by persons who have been authorized by ZEISS.
- ▶ Do not allow any cables, particularly power cords, to trail across the floor, where they can be snagged by people walking past.
- ▶ Protect the cables from excessive heat (e.g. halogen lamps, microscope fluorescence illumination).
- ▶ To avoid injuries due to potentially high surface temperatures, do not touch the camera's surface for a prolonged time.
- ▶ Do not position the equipment in a way that makes it difficult to operate or disconnect the device.

NOTICE

To avoid equipment damage, data loss, or corrupted data, read and adhere to the safety notes below.

- ▶ Protect the camera against mechanical impact. External damage may affect the operation of inner components.
- ▶ Keep chemicals and fluids away from the camera.
- ▶ Make sure there is sufficient ventilation of the camera head. Avoid direct exposure to sunlight and locations near heat sources (radiators, stoves). Overheating can cause noisy images.
- ▶ Use the camera in a clean and dry location.
- ▶ Attach all connectors firmly and securely.
- ▶ Use only the accessories supplied by ZEISS, when applicable.
- ▶ Use only normal microscope cleaning material to clean the camera housing.
- ▶ Contact your local ZEISS service organization if a repair is necessary. Do not disassemble the camera by yourself, otherwise the warranty will be lost.
- ▶ Save all your data, such as images, measurement data, archives, reports, forms and documents, at regular intervals on an external storage medium. Otherwise it cannot be avoided that access to this data may be lost as a result of operational errors or hardware defects. ZEISS accepts no liability for consequential damage resulting from insufficient data protection.

2.3 Limitation of liability

No warranty shall be assumed by ZEISS during the warranty period if the equipment is operated without observing the safety regulations. In any such case, ZEISS shall be exempt from statutory liability for accidents resulting from such operation.

2.4 Warranty

ZEISS shall be exempt from any warranty obligations should the user fail to observe the safety regulations. ZEISS only guarantees the safety, reliability, and performance of the system if the safety notes are closely observed.

2.5 Warning labels

All points that may pose special risks are additionally marked by warning labels (pictograms) on the camera. These warning labels indicate possible dangers. They are part of this instruction manual. They are to be kept in a clean and legible state. Warning labels that are damaged or no longer clearly legible must be replaced immediately. Always observe all warning labels on the camera.

2.5.1 Position of the warning labels

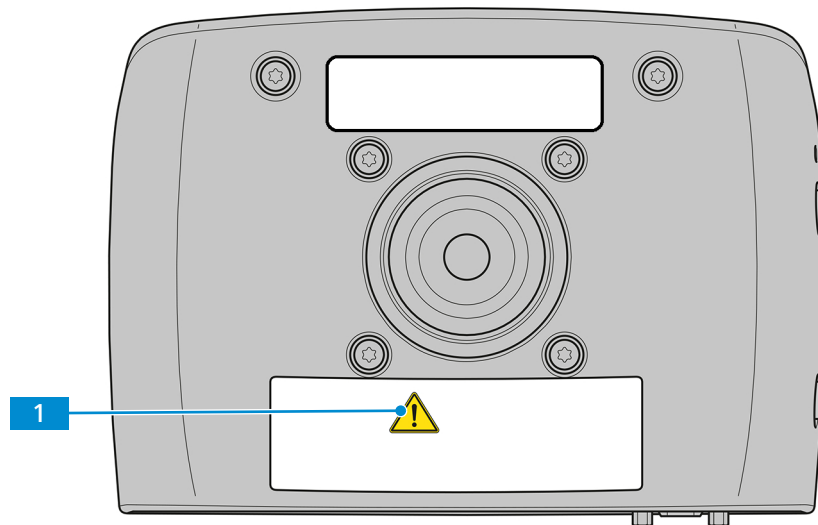



Fig. 1: Warning labels on the camera

2.5.2 Meaning of the warning labels

The meaning of each warning label is explained below.

No.	Symbol	Description
1		Follow the notes in the instruction manual and the supplied documents. For more information, see <i>Prevention of hazards</i> [▶ 7].

Tab. 3: List of attached Warning Labels

3 Technical Data and Conformity

3.1 Axiocam 208 color

3.1.1 Specifications

Features	Values
Sensor type	CMOS sensor with rolling shutter
Sensor Size	Diagonal 8.1 mm (1/2.1")
Effective Sensor Pixel Count	8.3 Megapixels: 3840 (H) x 2160 (V)
Pixel size	1.85 µm
Spectral Sensitivity	Approx. 400 nm – 700 nm, IR filter RGB Bayer color mask
Selectable Resolution	3840 x 2160 (Ultra HD, 4K) 1920 x 1080 (Full HD, 1080p)
Gain (Signal Amplification)	1x – 22x adjustable
Digitization	3 x 8 bit / pixel
Exposure Time Range (Integration time)	0.06 ms - 1 s
Image enhancement functions	Active denoising, active sharpening, auto white balance, HDR
Automatic features	Automatic exposure and gain regulation at Ultra HD resolution (4K), fast live image under low light conditions
Status-LED for camera	Color coded operation status
Interfaces	HDMI for monitor USB 3.0 Type-C for USB hub, flash drive, Wi-Fi adapter or PC connection Ethernet (RJ45) for LAN connection Micro-D for power and communication with dedicated stands
Wi-Fi compatibility	Via USB Wi-Fi adapter and router
Optical Interface	C-mount
Camera control buttons for stand-alone	1x Image capture 1x OSD (On Screen Display menu) 1x Camera factory reset
Stand-alone operation:	
<ul style="list-style-type: none"> ▪ Image storage format ▪ Video stream format ▪ Live frame rate via HDMI 	<ul style="list-style-type: none"> ▪ tiff or jpg ▪ mp4 ▪ 30 fps @ Ultra HD (4K)

Features	Values
Maximum live frame rate at configuration:	@ 4K (3840 x 2160)
<ul style="list-style-type: none"> ▪ HDMI ▪ Ethernet ▪ USB 3.0 	<ul style="list-style-type: none"> ▪ 30fps ▪ - ▪ 15 fps
Maximum live frame rate at configuration:	@ 1080p (1920 x 1080)
<ul style="list-style-type: none"> ▪ HDMI ▪ Ethernet ▪ USB 3.0 	<ul style="list-style-type: none"> ▪ 30 fps ▪ 30 fps ▪ 27 fps
Max. file size per image	.tiff up to: 24 MB (not content dependent) .jpg up to: approx. 0.5 MB – 3.3 MB (content dependent)
Size/ Weight	Approx. 135 x 97 x 54mm / 590 g
Housing	Blue painted aluminum and cooling fins on the top plate
Registration	CE, RoHS, CSA
Power supply	via Micro-D interface
Power consumption	Max. 9 W (24 V DC, 0.375 A)
Environmental conditions for storage and operation	+10°C to +40°C, max. 75% relative air humidity at 35°C, no condensation, free air circulation required, CAT II, pollution degree 2, altitude <2000m, indoor use
Environmental conditions for transport in packaging	-40 °C to +70 °C, max. 75 % relative air humidity at 35 °C
IP code	IP20
Operating systems:	
<ul style="list-style-type: none"> ▪ for ZEN ▪ for Labscope 	<ul style="list-style-type: none"> ▪ Windows 10 x64 Prof./Ultimate and higher ▪ Windows 10 x64 Prof./Ultimate and iOS v12 and higher
Supported Application Software	ZEN blue v3.0 and higher (includes ZEN lite/pro/system) ZEN core v2.7 and higher (includes ZEN starter/core) Labscope v2.9 (win) v2.8.3 (iOS) and higher
TWAIN plugin	Software interface to control camera by 3rd party application software
Order number	426570-9001-000
Info	

Computer hardware, operating system, and software may decrease the frame rates. All specifications are subject to change without notice.

3.1.2 Spectral Sensitivity

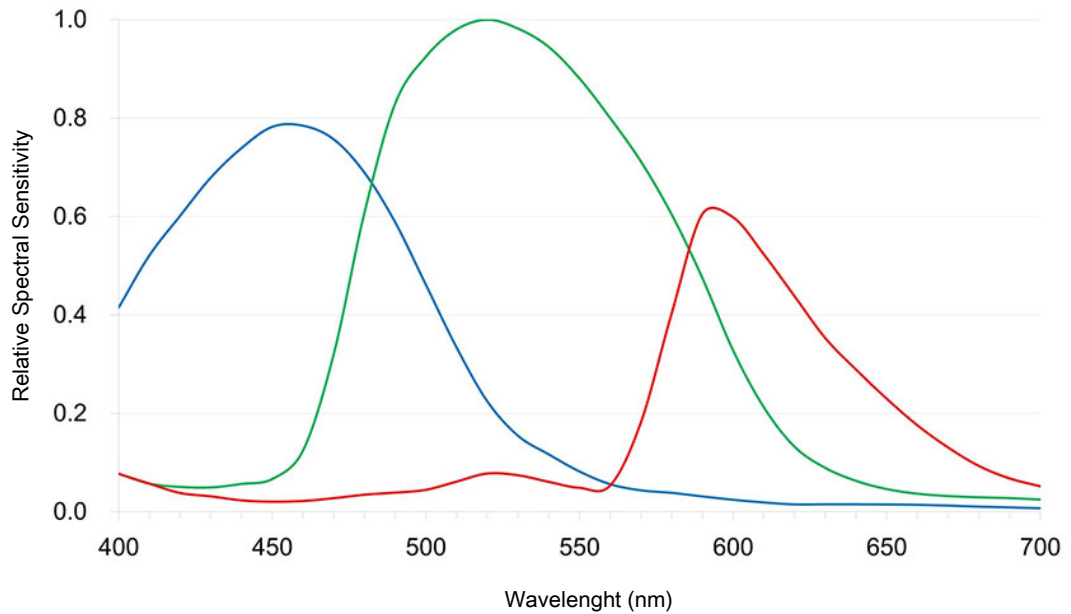

Fig. 2: Spectral Sensitivity of Axiocam 208 color (incl. IR Filter)

3.2 Axiocam 202 mono

3.2.1 Specifications

Features	Values
Sensor Type	CMOS sensor with global shutter
Sensor Size	Diagonal 13 mm (1/1.23")
Effective Sensor Pixel Count	2.1 Megapixels: 1920 (H) x 1080 (V)
Pixel size	5.86 μm
Spectral Sensitivity	Approx. 350 nm – 850 nm, protection glass (coated)
Selectable Resolution	1920 x 1080 (Full HD, 1080p)
Gain (Signal Amplification)	1x – 16x adjustable
Digitization	12 or 8 bit / pixel
Cooling	Passive cooling
Exposure Time Range (Integration time)	0.3 ms - 2 s
Image enhancement functions	Active denoising, active sharpening

Features	Values
Automatic features	Automatic exposure and gain regulation at Full HD resolution (1080p), fast live image under low light conditions
Status-LED for camera	color coded operation status
Interfaces	HDMI for monitor USB 3.0 Type-C for USB hub, flash drive, Wi-Fi adapter or PC connection Ethernet (RJ45) for LAN connection Micro-D for power and communication with dedicated stands
Wi-Fi compatibility	Via USB Wi-Fi adapter and router
Optical Interface	C-mount
Camera control buttons for stand-alone	1x Image capture 1x OSD (On Screen Display menu) 1x Camera factory reset
Stand-alone operation:	
<ul style="list-style-type: none"> ▪ Image storage format ▪ Video stream format ▪ Live frame rate via HDMI 	<ul style="list-style-type: none"> ▪ tiff or jpg ▪ mp4 ▪ 30 fps @ Full HD (1080p)
Maximum live frame rate at configuration:	@ 1080p (1920 x 1080)
<ul style="list-style-type: none"> ▪ HDMI ▪ Ethernet ▪ USB 3.0 	<ul style="list-style-type: none"> ▪ 30 fps ▪ 30 fps ▪ 27 fps
Max. file size per image	12bit .tiff: 4 MB (one channel, not content dependent) 8bit .tiff: 2 MB (one channel, not content dependent) 8 bit .jpg: approx. 0.1 MB – 1.3 MB (content dependent)
Size/Weight	Approx. 135 x 97 x 54mm / 590 g
Housing	Blue painted aluminum and cooling fins on the top plate
Registration	CE, RoHS, CSA
Power supply	via Micro-D interface
Power consumption	Max. 9 W (24 V DC, 0.375 A)
Environmental conditions for storage and operation	+10°C to +40°C, max. 75% relative air humidity at 35°C, no condensation, free air circulation required, CAT II, pollution degree 2, altitude <2000m, indoor use

Features	Values
Environmental conditions for transport in packaging	-40 °C to +70 °C, max. 75 % relative air humidity at 35 °C
IP code	IP20
Operating systems:	<ul style="list-style-type: none"> ▪ for ZEN ▪ for Labscope
Supported Application Software	ZEN blue v3.0 and higher (includes ZEN lite/pro/system) ZEN core v2.7 and higher (includes ZEN starter/core) Labscope v2.9 (win) v2.8.3 (iOS) and higher
TWAIN plugin	Software interface to control camera by 3rd party application software
Order number	426570-9011-000

Info

Computer hardware, operating system, and software may decrease the frame rates. All specifications are subject to change without notice.

3.2.2 Spectral Sensitivity

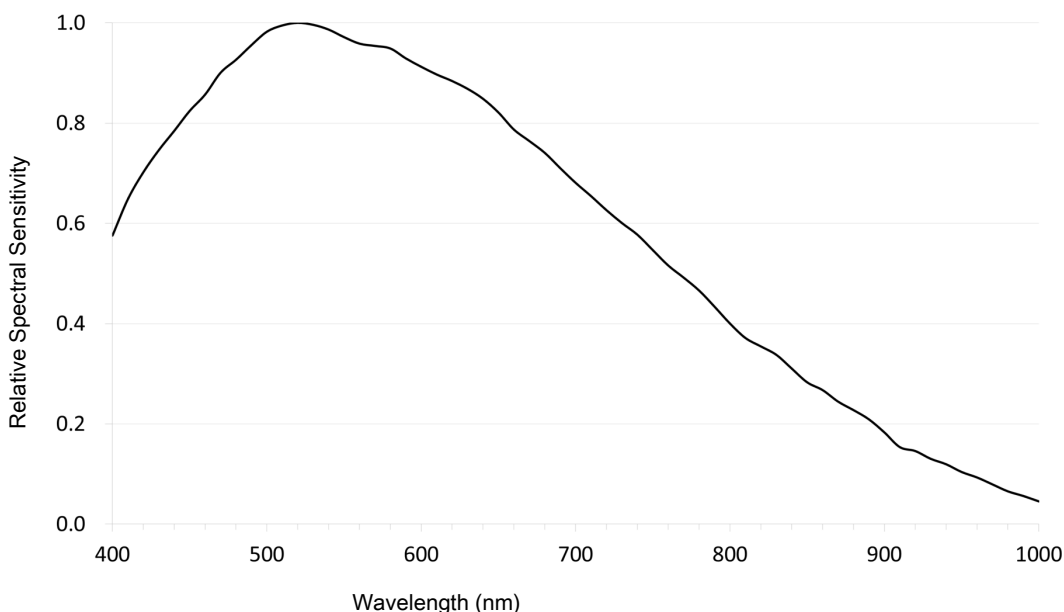





Fig. 3: Relative Spectral Sensitivity of Axiocam 202 mono

3.3 Applicable Standards and Regulations

Observe the generally applicable local and national safety and accident prevention regulations, as well as the applicable laws and regulations in your country. The camera and its accessories have been designed, manufactured and tested to comply with the guidelines and specifications as named in the following. The accordance to the relevant specification is indicated by a respective symbol on the unit.

3.3.1 Symbols on the camera

Symbol	Description
	<p>Conforms to:</p> <ul style="list-style-type: none"> ▪ EU Directive 2014/35/EU (LVD) ▪ 2014/30/EU (EMC) ▪ 2015/863/EU (RoHS)
	<p>Complies with EU Directive 2012/19/EU (WEEE)</p>
	<p>CSA certificate mark, conforms to:</p> <ul style="list-style-type: none"> ▪ CAN/CSA-C22.2 No. 61010-1-12 ▪ UL Std. No. 61010-1 (3rd edition)

Tab. 4: List of attached labels concerning standards and regulations

4 Shipment

4.1 Axiocam 208 color

- 1x Axiocam 208 color
- 1x Power & signal cable, camera to microscope stand (compatible with Aixolab 5 and Axioscope 5/7/Vario)
- 1x Power adapter with country-specific plug
- 1x USB 3.0 cable, Type-C to Type-A
- 1x USB 3.0 flash drive, Type-C and Type-A
- 1x USB hub, Type-C

Accessories for Stand-Alone and for Usage with Labscope

Order Number	Accessory
000000-0626-248	High-Speed-HDMI-Cable, Premium, Resolution 4K, 2m
000000-0626-246	Optical USB-Scroll Mouse
000000-0626-245	Keyboard, USB, Language DE
000000-0626-267	Keyboard, USB, Language US
426570-9110-000	Wi-Fi dongle package containing Wi-Fi Dongle and USB adaptor Type-C to Type-A

4.2 Axiocam 202 mono

- 1x Axiocam 202 mono
- 1x Power & signal cable, camera to microscope stand (compatible with Aixolab 5 and Axioscope 5/7/Vario)
- 1x Power adapter with country-specific plug
- 1x USB 3.0 cable, Type-C to Type-A
- 1x USB 3.0 flash drive, Type-C and Type-A
- 1x USB hub, Type-C

Accessories for Stand-Alone and for Usage with Labscope

Order Number	Accessory
000000-0626-248	High-Speed-HDMI-Cable, Premium, Resolution 4K, 2m
000000-0626-246	Optical USB-Scroll Mouse
000000-0626-245	Keyboard, USB, Language DE
000000-0626-267	Keyboard, USB, Language US
426570-9110-000	Wi-Fi dongle package containing Wi-Fi Dongle and USB adaptor Type-C to Type-A

5 Connecting the Camera

5.1 Camera layout and accessories

5.1.1 Camera connections

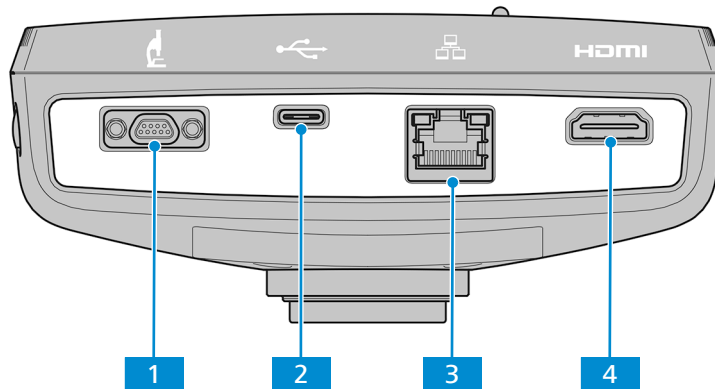

Fig. 4: Camera connector panel

No.	Name	Function
1	Micro-D port	Power supply and communication
2	USB 3.0 Type-C	Camera control and image data transfer
3	Ethernet port (RJ45)	Communication and image data transfer
4	HDMI port	Image data transfer to a certified monitor, TV or projector

5.1.2 Camera controls

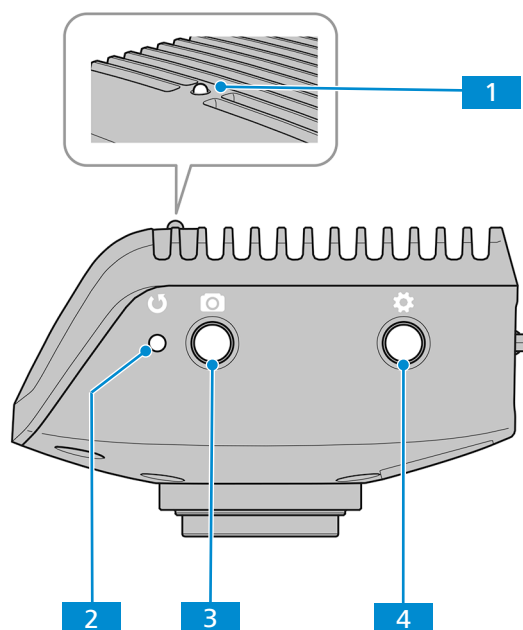

Fig. 5: Camera operator panel

No.	Name	Function
1	LED function indicator	Please see section <i>Function indicator signals</i> [▶ 25] for detail.
2	Camera factory reset button	Press to reset all parameters to default.
3	Image / video capture button	Press shortly for capturing an image. Press for five seconds to start recording a video. Press again shortly to stop the video recording.
4	OSD menu button	Press to open the OSD menu. Press again to close the OSD menu.





See also

📖 Acquiring Images and Videos [▶ 41]

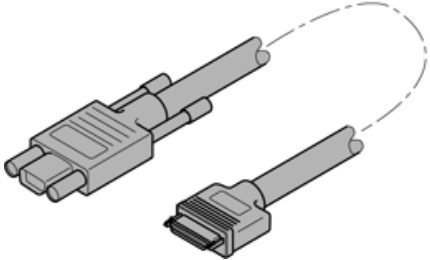
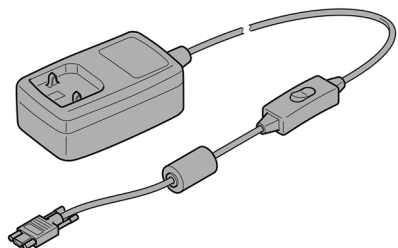
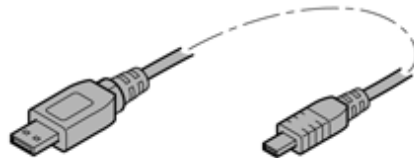
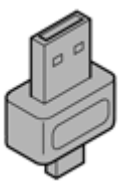
5.1.3 Accessories

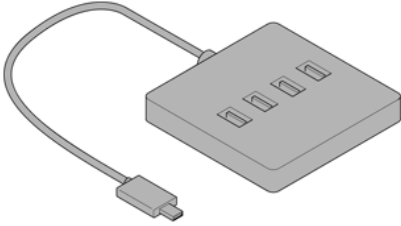
The following items are required for power supply and use of the ports:

Name	Figure	Remarks
Power & signal cable, camera to microscope stand		Connection between camera and compatible microscopes (e.g.: Axio-scope 5/7 or Axiolab 5, power is supplied via microscope)
Power adapter with country-specific plug		Power supply from external power socket if the camera is used with microscopes other than Axioscope 5/7 or Axiolab 5.
USB 3.0 cable, Type-C to Type-A		Connection between camera and PC
USB flash drive, Type C and Type A		Connection to camera (Type-C) or to USB hub (Type-A) for immediate image and video storage

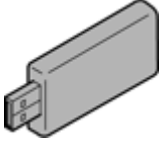
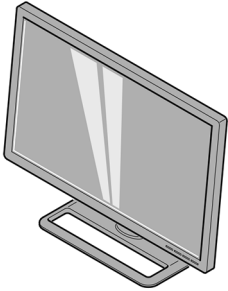
Name	Figure	Remarks
USB hub, Type-C		Connection between camera and multiple USB Type-A devices, such as keyboard, mouse and flash drive
Ethernet cable (not supplied in package)		Connection between camera and network or WLAN router
HDMI cable (not supplied in package, please order seperately: Order No. 000000-0626-248)		Connection between camera and monitor, TV, or projector
Mouse (not supplied in package, please order seperately: Order No. 000000-0626-246)		For control and navigation in the OSD menu
Keyboard (not supplied in package, please order seperately: Order No. 000000-0626-267 for US layout, Order No. 000000-0626-245 for DE layout)		For typing in the OSD menu
Wi-Fi Adapter package (not supplied in package, please order seperately: Order No. 426570-9110-000)		Wi-Fi Adapter package consisting of Wi-Fi adapter and USB adapter Type-C to Type-A for wireless transmission of camera images to PC or iPad with Labscope
Monitor TFT 32" 4K (not supplied in package, please order seperately: Order No. 410350-3201-000)		For display of camera image and operating the OSD menu

5.2 Mounting the camera to the microscope

To mount the camera to your microscope's camera port, use a C-mount camera adapter. The adapter is not included in the scope of delivery. You will find some suitable examples for adapters in the list below:

Camera	Port	Adapter	Order number
Axiocam 208 color	60N	Camera Adapter 60N-C 2/3" 0.5x	426112-0000-000
Axiocam 202 mono	60N	Camera Adapter 60N-C 2/3" 0.63x	426113-0000-000

NOTICE

Loss of warranty

The Axiocam 208 color is delivered with an integrated IR filter (infrared cut filter). The Axiocam 202 mono is delivered with a protective glass to shield the camera against dust and to reduce optical interferences.

- ▶ Do not remove the filter or the protective glass. Otherwise the warranty will be lost.

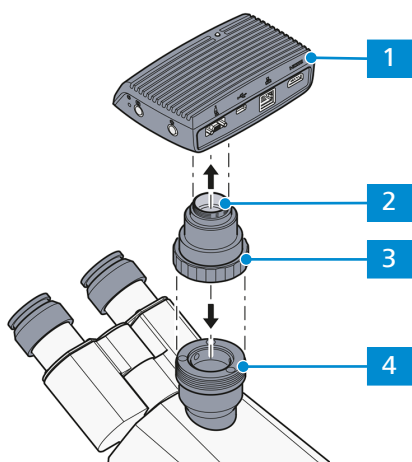

Fig. 6: Mounting the camera to the microscope

- 1** Camera
- 2** C-mount camera adapter
- 3** Ring nut
- 4** 60N port at microscope stand

1. Remove the dust cap from the camera's C-mount port.
2. Mount the C-mount camera adapter to the camera.
3. Attach the camera with the adapter to the microscope's 60N port.
4. Orient the camera to the stand and fix its position by tightening the ring nut.

5.3 Connecting the camera to the power supply

When connected to Axioscope 5/7 or Axiolab 5, the Axiocam 208 color or the Axiocam 202 mono are powered by the microscope. Otherwise the cameras have to be connected to the supply mains via the plug-in power supply.

5.3.1 Powering the camera via microscope

NOTICE

Risk of damage to the microscope or the camera

- ▶ Always switch off the microscope before you disconnect the power cable from the camera!

Prerequisite ✓ The camera is mounted to Axioscope 5/7 or Axiolab 5.

1. Insert the Micro-D plug of the power cable into the Micro-D port of the camera.
2. Insert the power cable's opposite connector into the corresponding socket on your microscope.

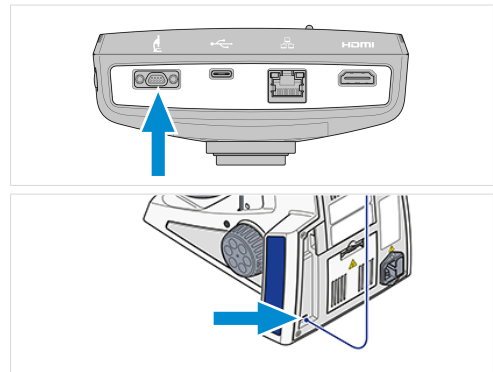

Info

Refer to the instruction manual of your microscope for further information.

5.3.2 Powering the camera via mains supply

Prerequisite ✓ The power supply has been adapted with the appropriate country-specific adapter.
✓ The camera is not already powered via a compatible microscope.

1. Insert the Micro-D plug of the plug-in power supply into the Micro-D port of the camera.

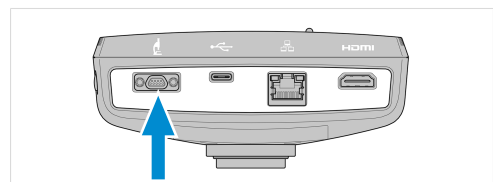

2. Insert the power plug of the plug-in power supply into a power outlet.

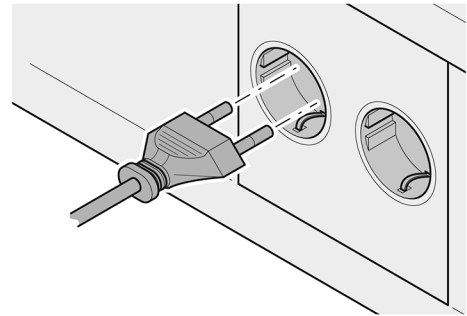

3. Turn on the camera via cable switch.

5.4 Connecting the camera to a display (without PC)

The camera can be connected to a certified monitor, TV, or projector for visualization of the live image data and for operating the OSD menu functions. Certain HDMI functions (e.g. audio, commands from monitor to camera) are not supported.

Info

If you connect the Axiocam 208 color / 202 mono to a monitor, these are the minimal monitor requirements:

- HDMI 1.4 or HDMI 2.0 input port
- 1920 x 1080 or higher resolution
- 16:9 or 16:10 aspect ratio
- Progressive scanning
- HDMI cable with less than 3 m length (shorter cable enables better signal integrity)

Note that the maximum resolution of the Axiocam 202 mono is Full HD (1920 x 1080), while the Axiocam 208 color supports resolutions up to Ultra HD (4K).

1. Insert the HDMI cable into the HDMI port of the camera.

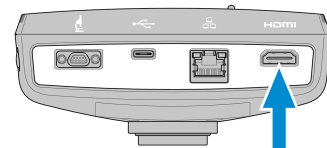

2. Insert the HDMI cable's opposite connector into the corresponding socket on your display device.
3. Set the display device's aspect ratio to 16:9 or Aspect.

For further camera settings using the **OSD** a mouse is required (e.g. Optical USB-Scroll Mouse, Order No. 000000-0626-246) . An additional keyboard is optional (Keyboard, USB, Design "Business Slim", Language English US, Order No. 000000-0626-267 or Keyboard, USB, Design "Business Slim", Language German, Order No. 000000-0626-245).

5.5 Connecting the camera to a network

If you want to connect the camera to a network, you can choose between several options, of which all require network access and the ZEISS imaging software Labscope (available as windows or iOS version). The camera identifies itself automatically to the network (DHCP) and is automatically recognized by Labscope, provided the device is on the same network.

NOTICE**Display errors**

In the event of an overloaded or slow WLAN, the live image of the camera may be delayed or incorrectly displayed on the iPad.

- ▶ If possible, use a high-performance 802.11n WLAN.
- ▶ Provide a sufficient contingent of free bandwidth for communication.

For an overview of all ZEISS Microscopy apps and further information on individual apps, visit <https://www.zeiss.com/microscopy/int/products/microscope-software/microscopy-apps.html?vaURL=www.zeiss.com/micro-apps>

5.5.1 Connecting camera via Ethernet

Prerequisite ✓ The camera is powered via mains supply or microscope.

1. Insert the Ethernet cable into the camera's Ethernet port.

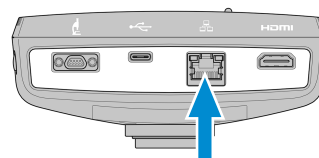

2. Insert the Ethernet cable's opposite connector into the corresponding socket on your WLAN router.

5.5.2 Connecting camera via Wi-Fi adapter

Prerequisite ✓ The camera is powered via mains supply or microscope.
 ✓ An USB Wi-Fi adapter is available.
 ✓ An USB hub is connected to the camera.
 ✓ An USB mouse is connected to the USB hub to operate the OSD.
 ✓ The camera is connected to a display via HDMI.

1. Insert the USB Wi-Fi adapter into the camera's USB Type-C port or into the USB hub.

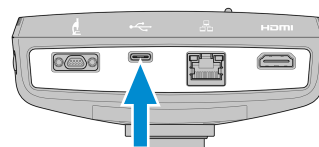

2. Open On Screen Display menu (see chapter *Opening the OSD menu* [▶ 26]).
3. Select Settings icon in Home Menu (*Home menu* [▶ 27]) to open the Settings menu.
4. Select Operating System Settings (*Settings menu* [▶ 30]) to open the Operating System menu.
5. Select Wi-Fi Settings.

The **Choose WLAN mode** menu shows up. It offers two ways to connect the camera to a Wi-Fi device (e.g. iPad or Laptop).

5.5.2.1 Using the camera as access point

Follow the subsequent instructions to directly connect your camera to the Wi-Fi device:

1. Select **As an access point** from the **Choose WLAN mode** menu.

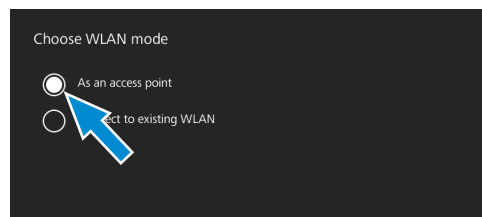

2. Click the **Next** button.
 - The subsequent screen appears.
3. Type in the network name (or keep default name) and password **ZEISS1846** into the respective input fields.
4. Click the **Save** button.
 - The camera can be found by other devices as access point: Other devices can connect to the camera using the specified network name and password.

5.5.2.2 Connecting to existing WLAN

Follow the subsequent instructions to connect your camera to an existing WLAN:

1. Select **Connect to existing WLAN** from the **Choose WLAN mode** menu.

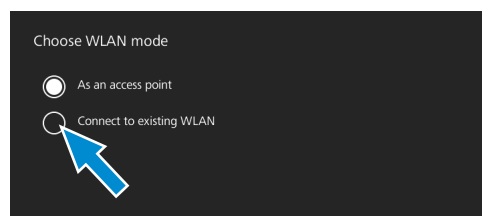

2. Click the **Next** button.
 - The subsequent screen appears.
3. Select the network name from the respective selection field.
4. Type in the password into the respective input field.
5. Click the **Save** button.
 - The camera is connected to the WLAN.
 - If the Wi-Fi device is connected to the same router, the camera appears in Labscope.

Info

If the WLAN list is empty or does not contain the one you want to connect to, wait for a few seconds and click again to refresh.

Info

Not all special characters are supported when typing in a password.

allowed: A~Z a~z 0~9 @ # % * .

not allowed: ! . , ; ? / \ & () " ` - ¥

5.6 Connecting the camera to a certified PC

The USB port can also be used for data transfer to the PC.

Prerequisite ✓ The camera is powered via mains supply or microscope.

1. Insert the USB 3.0 cable's Type-C connector into the corresponding socket on the camera.

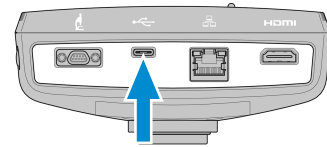

2. Insert the USB 3.0 cable's Type-A connector into the corresponding socket on the PC.

5.7 Function indicator signals

For the definitions of the LED color signals, refer to the list below:

Signal	Description
Pink	Camera starting
Blue	Power supplied and camera ready
Blue flash	Snapping/recording in process, and saving data to USB flash drive
Red flash	Firmware updating/factory resetting
Pink flash	No USB flash drive or the drive is full
Off	No power supplied

6 On Screen Display (OSD) Menu

Info

Certain functions of the OSD menu are only available with compatible microscope stands i.e. Axioscope 5/7 or Axiolab 5. For more information, please refer to the relevant microscope's manual.

6.1 Opening the OSD menu

When your camera is powered on and connected to a display device via HDMI, you can open or close the OSD menu by pressing the **Menu** button on the camera.

To operate the OSD, plug the USB hub (included in the package) into the camera's USB port. Then you can connect your mouse/keyboard (not included in the package) and the USB flash drive (included in the package) via the hub.

Info

A USB flash drive used should be of FAT32 format and have enough free space for storing the data.

6.1.1 Opening menu via camera's operator panel

Prerequisite ✓ The camera is connected to your display device via HDMI cable.

1. To open the **OSD** menu, press the **Menu** button on the camera's operator panel.

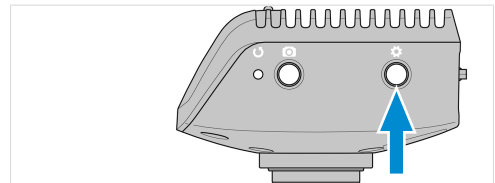

The **OSD** menu opens on your display device.

6.1.2 Opening menu via microscope stand buttons

Prerequisite ✓ The camera is connected to your display device via HDMI cable.

✓ The camera is mounted on a Axioscope 7 stand.

1. To open the **OSD** menu, press the microscope stand's **Snap** button and **Stage control** button simultaneously.

The **OSD** menu opens on your display device.

Info

For more information, please refer to the Axioscope 5/7/Vario operating manual.

6.1.3 Opening menu via network browser

Prerequisite ✓ The camera is connected to the same network as your display device (i.e. iPad or PC).

1. On the display device, open the network browser.
 2. Insert the camera's IP address into the browser window's address line and press **Enter**.
- The **OSD** menu opens on your display device.

6.2 Home menu

The **Home** menu gives you basic imaging controls to capture your images with minimum amount of effort.

The controls for selected options are highlighted blue.

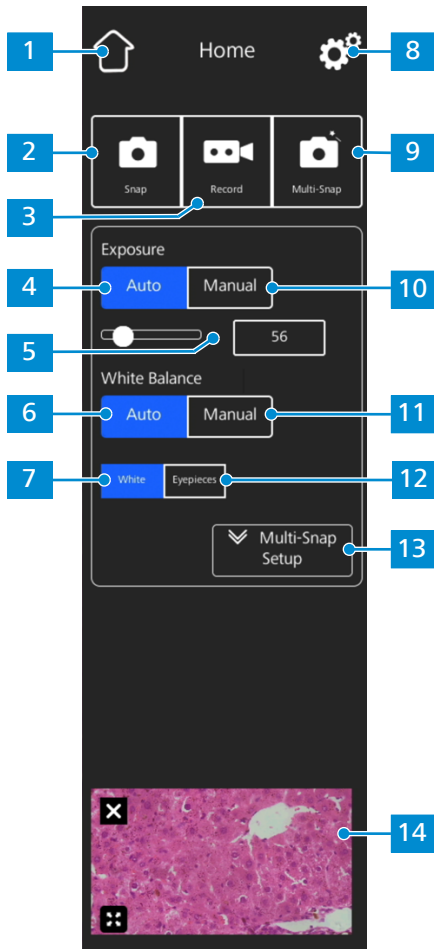
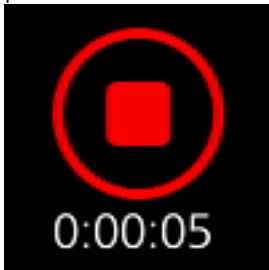
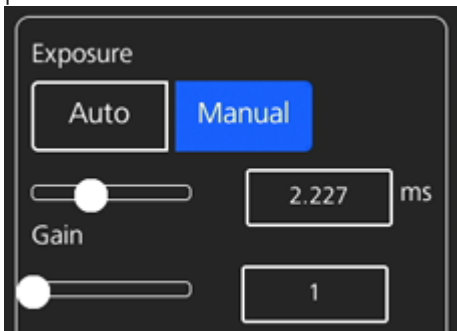
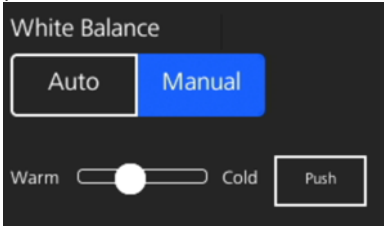



Fig. 7: Home menu

No.	Name	Description
1	Home icon	Opens the Home menu.
2	Snap button	Snaps a single image.
3	Record button	Starts a video recording. A time counter is displayed.

No.	Name	Description
		<p>When pushing the button the following controls expand:</p>  <ul style="list-style-type: none"> The recording can be stopped by clicking the red square symbol above the time display.
4	Auto Exposure button	Ensures consistent brightness of the image by continuously calculating the correct exposure time based on the current light intensity.
5	Target Intensity controls	In Auto Exposure mode, the light intensity can be fine-tuned using the slider or the input field.
6	Auto White Balance button (for Axio-cam 208 color)	Ensures a consistent color temperature of the image by continuously calculating the white balance. Please note: A proper functioning of the Auto White Balance mode requires enough empty area in the field of view.
7	White button (for Axio-cam 208 color)	If active, in the Auto White Balance mode the color temperature is calculated based on the assumption that the light source is white.
8	Settings icon	Opens the Settings menu.
9	Multi-Snap button (for Axioscope 5/7 and Axio-lab 5)	Performs a multi-channel acquisition. Please note: The Multi-Snap function requires that the camera is connected to a compatible microscope stand (correct light source and appropriate multi-band filter set). See the corresponding microscope user manual for details.
10	Manual Exposure button	<p>Enables you to manually re-adjust the exposure time, e.g. when the Auto Exposure mode doesn't deliver appropriate results.</p> <p>When pushing the button, the following controls expand:</p> 

No.	Name	Description
		<ul style="list-style-type: none"> The exposure time can be fine-tuned using the upper slider or input field. For exposure time range, refer to <i>Axiocam 208 color</i> [▶ 10] and <i>Axiocam 202 mono</i> [▶ 12]. The gain value can be set using the lower slider or input field.
11	Manual White Balance button (for Axiocam 208 color)	<p>Enables you to manually re-adjust the color temperature, e.g. when the Auto White Balance mode doesn't deliver appropriate results.</p> <p>When pushing the button, the following controls expand:</p>  <ul style="list-style-type: none"> The color temperature can be set warmer (more red) or colder (more blue) using the slider. The white balance can be calculated once by clicking the Push button.
12	Eyepieces button (for Axiocam 208 color)	<p>If active, in the Auto White Balance mode the color temperature of the image is matched to the light source's color temperature. The colors in the camera image, thus, resemble the colors seen through the eyepieces.</p>
13	Multi-Snap Setup expander (for Axioscope 5/7 and Axiolab 5)	<p>Enables you to adjust the settings for the Multi-Snap function.</p> <p>When pushing the button, the following controls expand:</p>  <ul style="list-style-type: none"> The fluorescence channels to be captured can be selected and unselected by clicking the corresponding buttons (UV, B, G, and R). The expander can be closed by clicking the Hide button.
14	Thumbnail area	<p>Shows a thumbnail of the last image taken, the first frame of the last video captured, or the merged image of the last multi-channel acquisition with overlaid pseudo-colors.</p> <ul style="list-style-type: none"> The thumbnail can be closed by clicking the Close symbol.

No.	Name	Description
		<ul style="list-style-type: none"> The thumbnail can be maximized to the full display by clicking the Expand symbol.

Tab. 5: **Home** menu, control elements

6.3 Settings menu

The **Settings** menu gives you more options for image settings, the opportunity to configure your microscope, as well as to define some basic operating system settings.

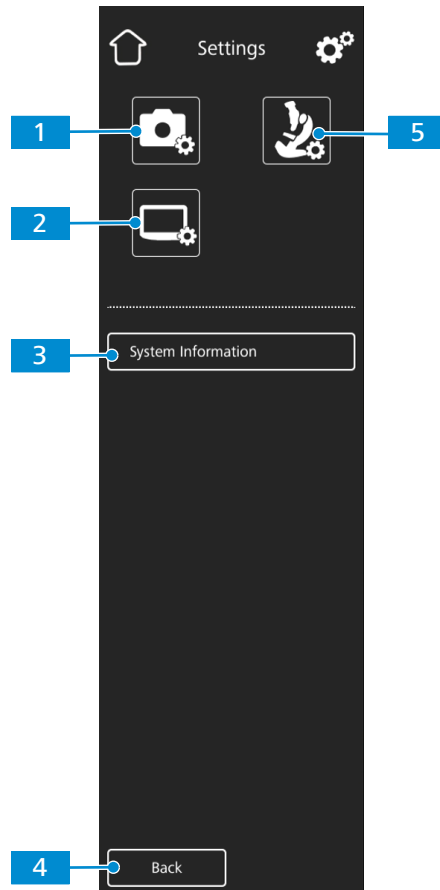

Fig. 8: *Settings menu*

No.	Name	Description
1	Image Settings	Opens the Image Settings menu.
2	Operating System Settings	Opens the Operating System menu.
3	System Information button	Shows the status of the entire camera/microscope system.
4	Back button	Opens the previous menu.
5	Microscope System Settings	Opens the Microscope System menu.

6.3.1 Image Settings menu

The **Image Settings** menu gives you more advanced controls to optimize your image. It also gives you some options to show different image information and how snapped images are shown.

The controls for selected options are highlighted blue.

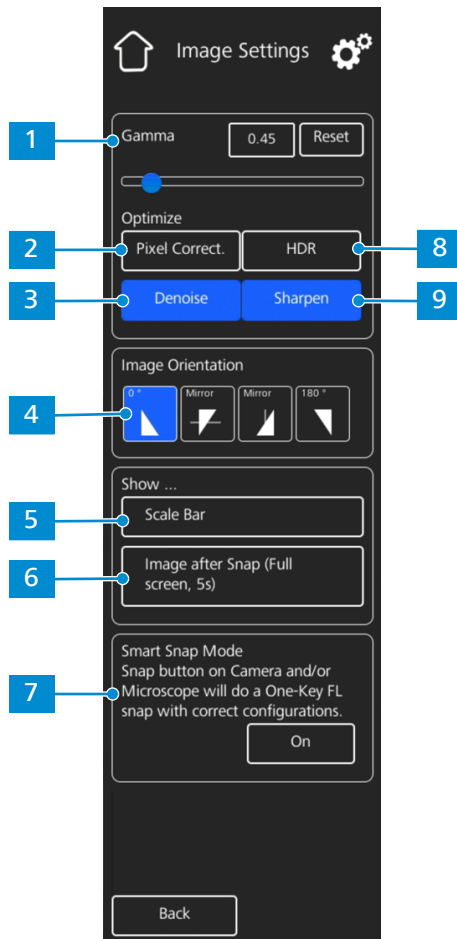

Fig. 9: Image Settings menu

No.	Name	Description
1	Gamma controls	<p>Enable you to adjust the gamma value.</p> <ul style="list-style-type: none"> The gamma value can be fine-tuned using the slider or the input field. The gamma value can be reset to default by clicking the Reset button. <p>Please note: For Axiocam 208 color the default gamma value is 0.45. For Axiocam 202 mono the default gamma value is 1.2.</p>
2	Optimize Pixel Correction button	<p>Corrects dead and hot pixels in the image.</p>

No.	Name	Description
3	Optimize Denoise button	Reduces noise.
4	Image Orientation controls	<p>Sets the image orientation.</p> <ul style="list-style-type: none"> ▪ 0°: original image orientation ▪ Mirror vertical: image mirrored in vertical direction ▪ Mirror horizontal: image mirrored in horizontal direction ▪ 180°: image rotated by 180°
5	Show Scale Bar button	<p>Shows a scale bar on the live display.</p> <p>Please note: The scale bar will also appear in the captured image.</p>
6	Show Image after Snap button	If activated, the image is shown on the full display for 5 seconds after being captured. The full display image can be closed or minimized to a thumbnail, if required.
7	Smart Snap Mode button (for Axioscope 5/7 and Axiolab 5)	<p>Activates the triggering of a multi-channel acquisition by pushing the snap button on the camera or microscope stand.</p> <p>Please note: The Multi-Snap function requires that the camera is connected to a compatible microscope stand (correct light source and appropriate multi-band filter set). See the corresponding microscope user manual for details.</p>
8	Optimize HDR button (for Axiocam 208 color)	Converts several images with different exposure times into a high contrast image or High Dynamic Range (HDR) image in order to show large differences in brightness (e.g. reflective samples) in detail.
9	Optimize Sharpen button	Sharpens details.

6.3.2 Microscope System menu

The **Microscope System Settings** menu provides access to some microscope configurations to be adjusted for easier imaging. For example, the microscope information can be updated if a new part is installed. If required, a configuration wizard guides through the entire configuration setup.

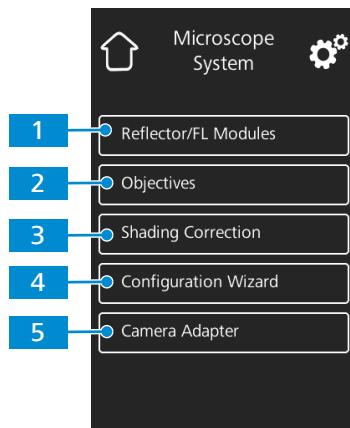

Fig. 10: Microscope System Settings menu

No.	Name	Description
1	Reflector / FL Modules button (for Axiolab 5, Axioscope 5/7)	Opens a drop-down list to define the item installed at the reflector turret's current position.
2	Objectives button (for Axiolab 5, Axioscope 5/7)	Opens a drop-down list to define the item installed at the objective turret's current position.
3	Shading Correction button	Opens a menu to define the shading correction for each combination of reflector, objective and light source, see <i>Applying Shading Correction</i> [▶ 33].
4	Configuration Wizard button (for Axiolab 5, Axioscope 5/7)	Opens a wizard to support you in setting up all microscope configurations listed above.
5	Camera Adapter button (for Axiolab 5, Axioscope 5/7)	Opens a menu to define the camera adapter being currently used. Please note: For recommended adapters, see <i>Mounting the camera to the microscope</i> [▶ 20].

6.3.2.1 Applying Shading Correction

Follow the subsequent instructions to define the shading correction for a combination of reflector, objective and light source:

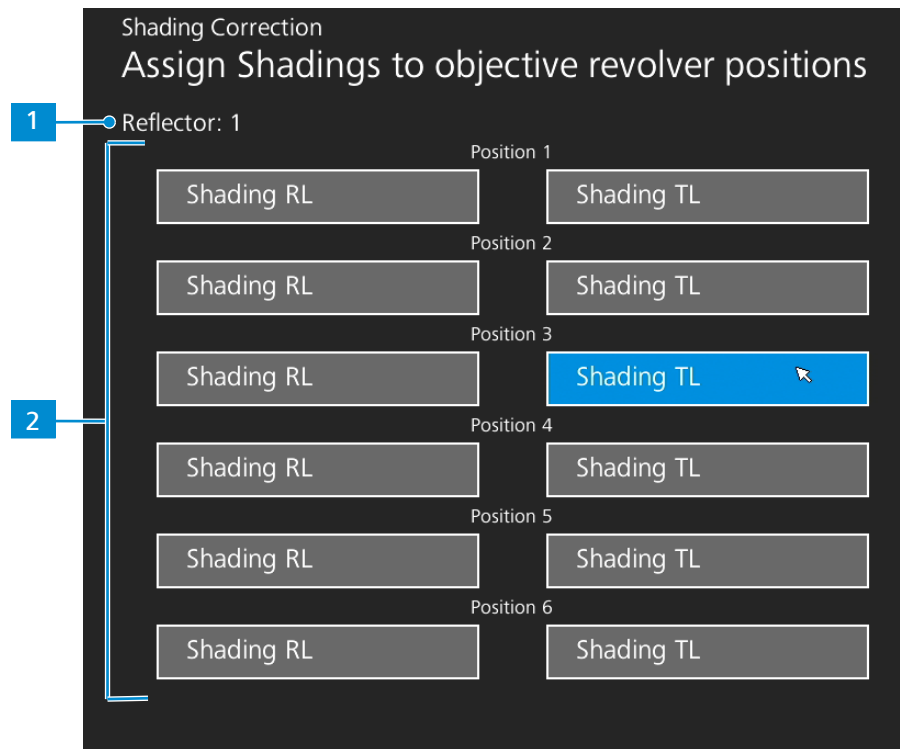

Fig. 11: Shading correction menu

1. Move in the reflector module and the objective to be configured.
2. Turn on the light source to be configured.
 - The current position of the reflector turret is indicated by **1**.
 - The current position of the objective turret and the light source (RL: reflected light, TL: transmitted light) are indicated by **2**.
3. Click the highlighted button to enter the shading correction menu for the current combination.
4. Follow the instructions on the display to perform the shading correction configurations.

Info

Shading correction may take a few seconds to take effect.

6.3.3 Operating System menu

The **Operating System** menu gives you options such as setting the language, defining the file-name format or updating the system firmware.

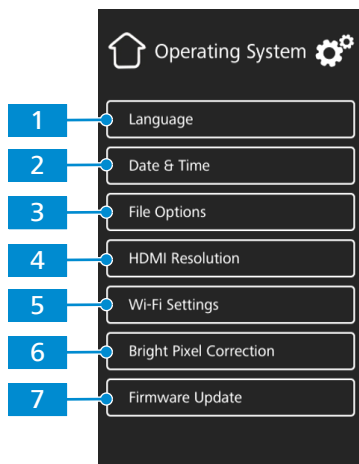

Fig. 12: Operating System menu

No.	Name	Description
1	Language button	Opens a menu to set English, Chinese or German as operating system language.
2	Date & Time button	Opens a menu to set date and time.
3	File Options button	Opens a menu to set the filename format and the file type for captured images, see <i>File Options menu</i> [▶ 35].
4	HDMI Resolution button (for Axiocam 208 color)	Opens a menu to set the desired HDMI resolution for live view. Please note: <ul style="list-style-type: none"> Switching from 1080p to 4K must be confirmed by pressing the Confirm button. The camera restarts automatically for the new resolution to take effect. If the connected monitor does not support 4K it automatically switches back to 1080p after 20 seconds.
5	Wi-Fi Settings button (for USB Wi-Fi adapter)	Opens a workflow to set up a wireless connection, see <i>Connecting the camera to a network</i> [▶ 22].
6	Bright Pixel Correction button	Opens a workflow to perform Bright Pixel Correction, see <i>Bright Pixel Correction menu</i> [▶ 36].
7	Firmware Update button	Starts a firmware update when the update file is available via the USB interface, see <i>Updating the firmware</i> [▶ 43].

6.3.3.1 File Options menu

The **File Options** menu allows you to predefine a template for file naming.

The controls for selected options are highlighted blue.

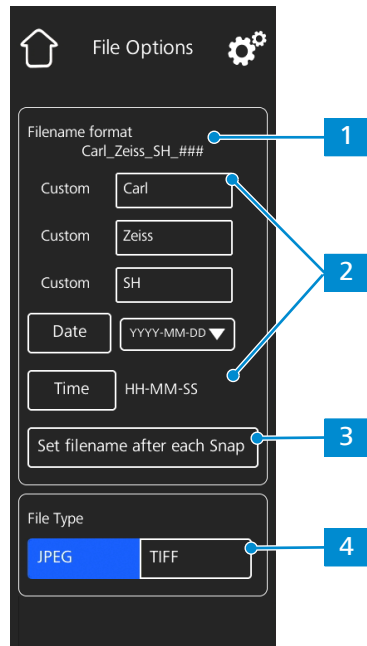

Fig. 13: File Options menu

No.	Name	Description
1	Filename format example	Shows the template of the filenames based on the currently selected components.
2	Filename format components	<p>Allows you to adjust the filename template.</p> <ul style="list-style-type: none"> Static text components (e.g. for sample names etc.) can be added by typing text into the Custom fields. Empty fields will be removed from the template. The date and time format can be set. A counter number is appended to each filename by default.
3	Set Filename after each Snap	Activates a prompt after each image capturing to manually set the filename.
4	File type selection	Allows you to set the file type (JPEG or TIFF) for captured images. For Axiocam 202 mono, you can additionally choose to save a TIFF image as 8-bit or 12-bit.

6.3.3.2 Bright Pixel Correction menu

The **Bright Pixel Correction** menu allows you to apply the **Bright Pixel Correction** procedure. This procedure corrects newly developed bright (or hot) pixels due to long exposure times, high gain settings or cosmic events.

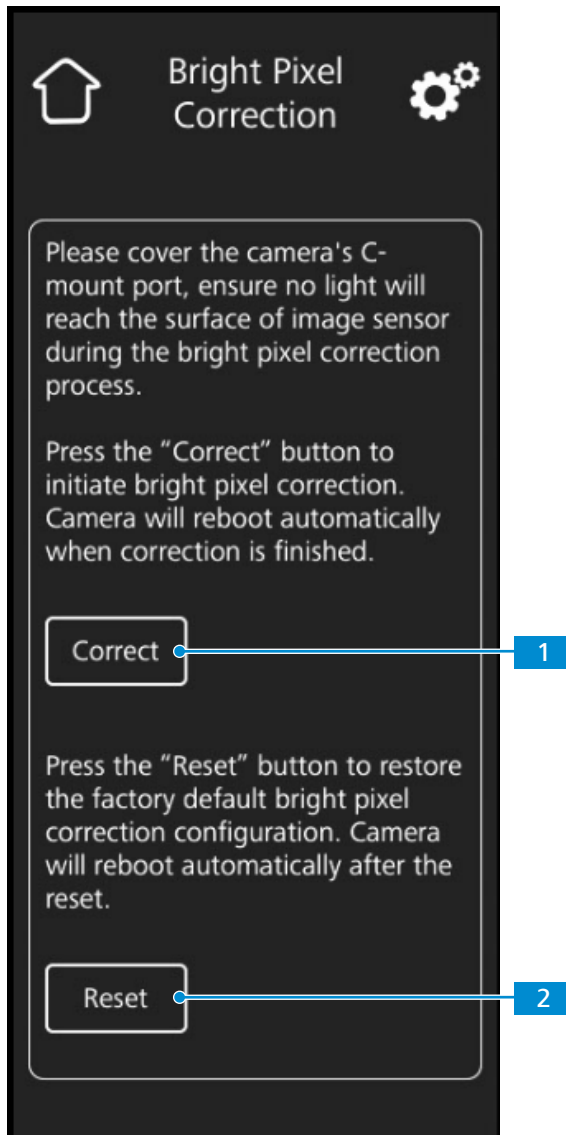

Fig. 14: Bright Pixel Correction menu

No.	Name	Description
1	Correct button	Initiates Bright Pixel Correction.
2	Reset button	Restores the factory default Bright Pixel Correction configuration.

Applying Bright Pixel Correction

- Prerequisite** ✓ The C-mount port is closed so that no light will reach the image sensor during the procedure. You can close the C-mount port by either closing the light path of the microscope stand or detaching the camera from the stand and protect sensor from light by screwing the protective cap onto the camera's c-mount thread.
- Tap the **Correct** button.
 - Do not operate the camera during the procedure.
 - If light reaches the sensor, the procedure fails. Either cover the camera properly or reset the Bright Pixel configuration before restarting the procedure.

The Bright Pixel Correction procedure is applied.
The camera reboots after a successful procedure.

7 Installing Software and Drivers

7.1 Installing software on PC

To acquire images with the camera(s) on a PC, you must install ZEISS software (e.g. ZEN or Lab-scope). You will find the installation files on the USB flash drive delivered. The camera drivers are also installed during the software installation. The latest version of ZEISS software products can be downloaded from our web page: <https://portal.zeiss.com/download-center/software/mic>

Prerequisite ✓ The camera is connected to the PC.

1. Install the software according to the installation guide delivered with the software.
2. To install the camera drivers, confirm the corresponding prompts that are displayed during the software installation process.
3. When the installation is finished, restart your PC.
4. In the device manager of your PC, verify that the installation was successful.

Info

For information on how to acquire images with the specific software, please refer to the respective software manual.

7.2 Installing software on iPad

1. From your iPad, go to the App Store and search for "Labscope" by ZEISS.
2. Follow the instructions on your iPad to install the app.

7.3 Installing TWAIN plugin on PC

The TWAIN plugin for Axiocam 208 color / 202 mono is a standardized software interface to call up and control basic camera functions via a TWAIN-compatible non-ZEISS app.

1. Go to <https://portal.zeiss.com/download-center/software/mic>.
2. Select **TWAIN** from the list.
3. Click on the **Download** Button.
→ The installation file is downloaded.
4. Open your **Downloads** folder and unzip the TWAIN installation file.
5. Double-click the **TWAIN** installation file (.exe).
6. Follow the instructions of the wizard.

For more information see the **Quick Guide ZEISS TWAIN for Axiocam 202/208**. You can find the PDF document in the **TWAIN** download folder.

7.4 Installing TWACKER DEMO Application

To demonstrate the image acquisition with the **TWAIN** plugin you can use the **TWACKER** application. **TWACKER** is not mandatory for operating the **TWAIN** plugin. If your laboratory software supports the **TWAIN** standard, you don't need to install **TWACKER**.

1. Go to <https://portal.zeiss.com/download-center/software/mic>.
2. Select **TWAIN** from the list.

3. Click on the **Download** Button.
 - ➔ The installation file is downloaded.
4. Open your **Downloads** folder and unzip the TWAIN installation file.
5. Double-click the **TWACK_32.msi** installation file.
6. Follow the instructions of the wizard.

For more information see the **Quick Guide ZEISS TWAIN for Axiocam 202/208**. You can find the PDF document in the **TWAIN** download folder.

8 Acquiring Images and Videos

8.1 Introduction

The Axiocam 208 color and the Axiocam 202 mono are high definition cameras for color and monochromatic imaging, respectively. They are suitable for use as accessories for educational and routine microscopy in laboratory environments and for use by trained laboratory personnel. The cameras have been designed to be used in the field of light microscopy for general observation, routine work, and simple applications in which a sufficient amount of light is available.

8.2 Basic procedure using operator panel

- Prerequisite** ✓ An USB flash drive has been inserted into the camera's USB port or into the USB hub connected to the camera.
1. Position your specimen on the microscope and adjust the microscope to see a focused image through the eyepieces.
 2. Set the microscope light path to divert the image to the camera (e.g. adjust the microscope's tube slider to **50% camera** and **50% eyepieces**).
 3. To take a single image, briefly press the **Capture** button on the camera.
→ The image is saved to the USB flash drive in either JPEG or TIFF format.
 4. To start video recording, press the **Capture** button on the camera for about 5 seconds.
 5. To finish video recording briefly press the **Capture** button on the camera once again.
→ The video is saved to the USB flash drive in MP4 format.

8.3 Basic procedure using OSD menu

- Prerequisite** ✓ The USB flash drive and mouse/keyboard have been inserted into the USB hub connected to the camera.
- ✓ The camera is connected to a monitor via HDMI.
- ✓ The OSD menu has opened by pressing the menu button on the camera
1. Position your specimen on the microscope and adjust the microscope to see a focused image on the monitor.
 2. To take a single image, click on the **Snap** button in the **OSD** menu.
→ The image is saved to the USB flash drive in either JPEG or TIFF format.
 3. To start video recording, click on the **Record** button in the **OSD** menu.
 4. To finish video recording click on the **Stop** button in the **OSD** menu.
→ The video is saved to the USB flash drive in MP4 format.

8.4 Image acquisition with Labscope

Upon first starting Labscope, each screen starts with an overlaying information screen explaining the functions. Refer to the displayed information for using the software. Disable or re-enable the information screens in the software's **Settings** menu on your PC monitor iPad.

Info

For support in using Labscope, visit our support forum under <https://forums.zeiss.com/microscopy/community/viewforum.php?f=34>. Please check the Labscope threads for problem-solving notes.

9 Care and Maintenance

To ensure the optimum performance of the device, preventive maintenance work should be performed at regular intervals.

Time interval	Component	Activity
As required	Infrared filter or protective glass	<i>Cleaning</i> [▶ 43]
As required	Firmware	<i>Update</i> [▶ 43]

Tab. 6: Maintenance plan

9.1 Optical system

The internal optical components of the camera should always be protected. If no lens, or camera adapter with optics, is screwed into the camera's C-Mount thread, the camera's sensor and protective glass must be protected by screwing the protective cap onto the camera's C-Mount thread.

9.2 Cleaning the infrared filter or protective glass

NOTICE

Sensitive optical parts

An inadequate handling of optical components may damage the components or decrease the device's imaging quality. The unauthorized handling of device components leads to the loss of warranty.

- ▶ Do not remove the filter or the protective glass.
- ▶ Do not clean the sensor directly.
- ▶ Do not use tap water to clean the IR filter.

Tool / part	Quantity
Soft brush	1
Cotton	1
Cleaning fluid for optics	1

Tab. 7: Tools and parts

1. Use a soft brush or cotton to wipe away dry dust from the front side of the infrared filter or the protective glass.
2. Use cotton and cleaning fluid for optics to wipe away more serious contamination from the infrared filter.

9.3 Updating the firmware

Follow the subsequent instructions to update the camera's firmware:

1. Download the latest firmware from the webpage <http://www.zeiss.com/microscopy/int/downloads.html>.

2. Save the latest firmware update package (".tar" file) to the root folder of the USB flash drive (contained in the scope of delivery).
3. Insert the flash drive into the connected USB hub.
4. At the OSD menu, navigate to **Settings > Operating System**.
5. Open the **Firmware Update** menu and press the update button.

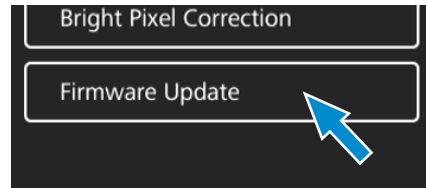

- Note that the update procedure takes several minutes.
- Do not operate the camera or unplug the USB flash drive during the update procedure.

The firmware is updated.

10 Troubleshooting

10.1 ZEN software

Symptom	Cause	Measure
Camera does not appear in the menu for selectable cameras.	The camera is not properly connected.	Check and adjust the camera connections to PC and power supply, if necessary.
	The software and the drivers are not properly installed.	Make sure you installed the software and the drivers with administrative rights and according to the instructions in this manual.
	Incompatible accessories (e.g. USB adapters, cables etc.) were used, so the camera was brought into wrong mode and failed to be recognized.	<ol style="list-style-type: none"> 1. Connect the camera to the PC with the accessories provided in the delivery package. 2. Restart the camera.
	The PC's USB driver is outdated.	Upgrade to the latest driver provided by the PC manufacturer.
No camera image visible on the screen.	The camera is not properly connected.	<ol style="list-style-type: none"> 1. <i>Make sure, the camera's status LED constantly lights blue.</i> [▶ 25] 2. If necessary, check and adjust the camera connections to PC and power supply. 3. Restart the camera.
	The illumination reaching through to the camera is not sufficient.	<ol style="list-style-type: none"> 1. Check the light path settings of the microscope. 2. If necessary, check and adjust the position of the beam splitter between the ocular and the camera port. 3. If necessary, check and adjust the setting of the aperture diaphragm of the microscope, if necessary. 4. Execute an automatic exposure measurement.
	Inappropriate display settings are used.	Check and adjust the display device's settings for live imaging, if necessary.
The color of the displayed image taken by Axiocam 208 color does not correspond to the image seen through the eyepieces.	The color matching is inappropriate.	<p>Set the color temperature.</p> <p>Check the monitor's color temperature setting. If necessary, reduce the color temperature to the lowest value possible.</p>

Symptom	Cause	Measure
The color of the displayed image taken by Axiocam 202 mono does not correspond to the image seen through the eyepieces.	Unsuitable overlay colors are used to represent fluorescence dyes.	Select alternative overlay colors.

10.2 Camera

Symptom	Cause	Measure
The LED indicator is off.	The camera is not powered on properly.	In case of Axioscope 5/7 and Axiolab 5, make sure the microscope is powered on and the camera is connected to microscope via Micro-D power cable. Alternatively, make sure the camera is powered by the plug-in power supply.
The LED indicator flashes red.	The camera is updating firmware or being reset.	NOTICE! Do not switch off the power supply.
The image / video cannot be saved to the USB flash drive.	USB flash drive is not in correct format.	Format the USB flash drive to FAT32 format on a PC.
	USB flash drive has not enough free memory.	Make sure there is enough free memory on the flash drive.
	USB flash drive cannot be recognized.	Restart the camera.
The firmware update does not function.	USB flash drive is not in correct format.	Format the USB flash drive to FAT32 format on a PC.
	USB flash drive does not enough free memory.	Make sure there are at least 200 MB of free memory on the USB flash drive.
	USB flash drive cannot be recognized.	Restart the camera.
	The firmware cannot be found.	Make sure the latest firmware is stored to the root folder of the USB flash drive.
	The firmware is not uploaded properly.	Restart the firmware update process and exactly follow the instructions in the firmware update menu.
The camera date and time is not correct.	Date and time are not set correctly.	<ol style="list-style-type: none"> At the OSD menu, navigate to Settings > Operating System. Tap the Date & Time button. Set the camera date and time.
	The buffer battery is empty.	Please contact your local ZEISS service organization to change the battery. The expected battery lifetime is approx. 4-5 years.

Symptom	Cause	Measure
The image has severe noise.	The amplification (gain) is set too high.	Manually reduce the gain value.
	The exposure time is set too low.	Manually adjust the exposure time.
	The light intensity is set too low.	Increase the light intensity. Activate denoise function in Image setting menu.
The image is too dark or too bright.	Automatic exposure time has not been activated.	Activate the automatic exposure settings or manually adjust the exposure settings to the current light situation.
The camera settings are not saved after a camera restart.	The camera has been powered off too early after changing the settings.	For the settings to be automatically stored, wait at least 5 seconds after changing the settings before you power off the camera.
Monitor connected via HDMI does not display an image.	The camera is not delivering a signal, or signal is not compatible with the monitor.	Ensure that the camera has been switched on for at least 30 seconds and the LED indicator is blue. Check the plug connections on the camera and monitor.
For Axiocam 208 color, when switching to 4K, the monitor becomes black and then reverts to 1080p.	The monitor does not support 4K.	Use a monitor supporting 4K resolution (e.g. Monitor TFT 32" HP Z32, Order No. 410350-3201-000), listed on ZEISS micro-shop website.
The image appears distorted on full screen monitor.	The monitor's image aspect ratio is not set to 16:9.	Set the monitor's aspect ratio to 16:9.
The image is blurred on the screen, but the sample is in focus through the eyepieces.	The focus plane of the camera is different from that of the eyepieces.	<ol style="list-style-type: none"> 1. Focus the sample through the eyepieces. 2. Calibrate the camera adaptor until image is in focus on the monitor.
Buttons do not react when being pressed.	The buttons are temporarily locked, as the camera is being accessed exclusively from the PC or network.	Control the camera via PC software or ZEISS app, or close the PC software or ZEISS app.
The Camera otherwise behaves abnormally.	The camera may have been brought into a non-intended state.	Press the Camera factory reset button on the camera.

10.3 Labscope

Info

For support in using Labscope, visit our support forum under <https://forums.zeiss.com/microscopy/community/viewforum.php?f=34>. Please check the Labscope threads for problem-solving notes.

11 Disposal and Recycling

This product has been developed, tested and manufactured in accordance with the applicable environmental provisions and directives of the European Union:

- The product and its accessories comply with EU directives 2015/863/EU (RoHS) and 2012/19/EU (WEEE), insofar as these apply to this product.
- ZEISS has implemented a take-back and recycling process that ensures that proper recycling is carried out in accordance with the aforementioned EU directives.
- Please contact your ZEISS sales/service organization for details relating to disposal and recycling.
- This product must not be disposed of with domestic waste or using municipal waste disposal services. In the event of resale, the seller must inform the buyer of the need to dispose of the product appropriately.

Carl Zeiss Microscopy GmbH
Carl-Zeiss-Promenade 10
07745 Jena
Germany

phone: +49 3641 64 3161
fax: +49 3641 64 3439
info.microscopy@zeiss.com
www.zeiss.com/microscopy